

© lutz-blades.com



**FILM BLADES MADE BY LUTZ BLADES –
HIGH-PERFORMANCE BLADES FOR HIGH-PERFORMANCE FILM**

CUSTOM BLADES

FILM AND FOIL

CHEMICAL FIBRES AND FIBREGLASS

MEDICAL

FOOD

DIY

AUTOMOTIVE

TEXTILES



PRECISION. SHARPNESS. YOUR SUCCESS.
exactly

Reasons why you need LUTZ BLADES:



PRECISION.

Our maxim is precision – and it is this principle that accompanies every stage from the initial idea to the finished product. Right through to the ideal solution for your specific cutting application to ensure your requirements are met. Throughout every design and development stage and every production step – blade after blade after blade.



SHARPNESS.

Your competitive advantage when you use products from LUTZ BLADES for cutting film is the sum of all our efforts and the details we guarantee you. We are pleased to show you those details because your success is our objective – from the first to the millionth blade.

YOUR SUCCESS. exactly



Your competitive advantage when you use products from LUTZ BLADES for automotive cutting applications is the sum of all our efforts and the details we guarantee you. We are pleased to show you those details because your success is our objective – from the first to the millionth blade.



FILM BLADES MADE BY LUTZ BLADES – HIGH-PERFORMANCE PRODUCTS FOR HIGH-PERFORMANCE FILM

Tough film which is also highly elastic? Additives present? Impact loads and lateral forces? There is no doubt that film manufacture is a high-performance process.

LUTZ BLADES manufactures high-grade special-purpose blades for industrial applications.

We make use of a wide range of steel qualities, tungsten carbides and ceramics.

In terms of material, heat-treatment and cutter geometry, our blades are designed specifically to meet the application needs of the user.











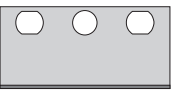

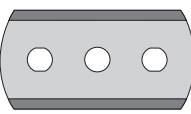
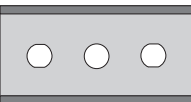
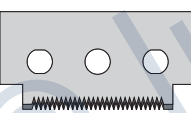



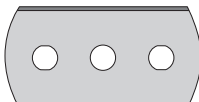







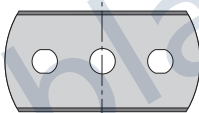

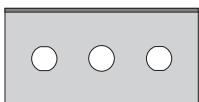



CUSTOM BLADES | FILM AND FOIL | CHEMICAL FIBRES AND FIBREGLASS | MEDICAL | FOOD | DIY | AUTOMOTIVE | TEXTILES







LUTZ BLADES website are subject to copyright and other proprietary rights.
LUTZ BLADES allows access to all its website content for viewing purposes. Copying and reproducing content (copy images etc.) for anything more than transient use is not permitted. This content may not be modified or used on other websites or networked computers without prior written approval by LUTZ GmbH & Co. KG.

LUTZ BLADES will pursue all violations against trademark law regarding its trademarks.
Copyright: © COPYRIGHT LUTZ GmbH & Co. KG, Solingen, Germany. All rights reserved. Copy, photos, graphics, technical drawings, layouts and other information used in all our publications and their arrangements on our

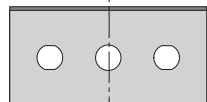
Proprietary rights: The owner of the brandnames used by LUTZ BLADES is LUTZ GmbH & Co. KG, Solingen, Germany (unless otherwise stated). Third Parties are explicitly prohibited from using any of the brandnames, logos or marks of any kind found there. This applies in particular to the internationally registered trademark "LUTZ BLADES exactly", which consists of words and graphic symbols.
E & OE: Brandnames marked with an asterisk (*) are not owned by LUTZ GmbH & Co. KG. Subject to our general terms & conditions on the Internet at www.lutz-blades.com.

| Ref. | Length (mm) | Width (mm) | Thickn. (mm) |
|---|-------------|------------|--------------|
|  | 39.0 | 18.8 | 0.30 |
| 0310.0300 | | | |
|  | 34.0 | 8.0 | 0.30 |
| 0399.0300 | | | |
|  | 43.0 | 22.2 | 0.40 |
| 0405.0400 | | | |
|  | 43.0 | 22.2 | 0.40 |
| 0406.0400 | | | |
|  | 43.0 | 21.5 | 0.30 |
| 9704.0300 | | | |
|  | 39.0 | 18.9 | 0.25 |
| 0290.0250 | | | |

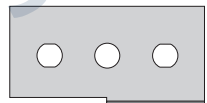
| Ref. | Length (mm) | Width (mm) | Thickn. (mm) |
|---|-------------|------------|--------------|
|  | 43.0 | 22.2 | 0.06 |
| 0400.0060 | | | |
|  | | | 0.08 |
| 0400.0080 | | | |
|  | | | 0.10 |
| 0400.0100 | | | |
|  | | | 0.13 |
| 0400.0130 | | | |
|  | | | 0.15 |
| 0400.0150 | | | |
|  | | | 0.20 |
| 0400.0200 | | | |
|  | | | 0.30 |
| 0400.0300 | | | |
|  | | | 0.40 |
| 0400.0400 | | | |
|  | | | 0.65 |
| 0400.0650 | | | |
|  | 43.0 | 22.2 | 0.10 |
| 0403.0100 | | | |
|  | | | 0.15 |
| 0403.0150 | | | |
|  | | | 0.30 |
| 0403.0300 | | | |
|  | 43.0 | 22.2 | 0.06 |
| 0410.0060 | | | |
|  | | | 0.08 |
| 0410.0080 | | | |
|  | | | 0.10 |
| 0410.0100 | | | |
|  | | | 0.13 |
| 0410.0130 | | | |
|  | | | 0.15 |
| 0410.0150 | | | |
|  | | | 0.20 |
| 0410.0200 | | | |
|  | | | 0.30 |
| 0410.0300 | | | |
|  | | | 0.40 |
| 0410.0400 | | | |
|  | | | 0.65 |
| 0410.0650 | | | |
|  | 38.0 | | 0.10 |
| 0501.0100 | | | |
|  | | | 0.15 |
| 0501.0150 | | | |
|  | | | 0.20 |
| 0501.0200 | | | |
|  | | | 0.30 |
| 0501.0300 | | | |
|  | | | 0.40 |
| 0501.0400 | | | |

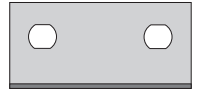
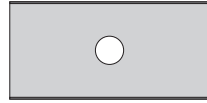
| Ref. | Length (mm) | Width (mm) | Thickn. (mm) |
|---|-------------|------------|--------------|
|  | 43.0 | 22.2 | 0.10 |
| 0402.0100 | | | |
|  | | | 0.15 |
| 0402.0150 | | | |
|  | | | 0.20 |
| 0402.0200 | | | |
|  | | | 0.30 |
| 0402.0300 | | | |
|  | | | 0.40 |
| 0402.0400 | | | |
|  | 43.0 | 22.2 | 0.10 |
| 0423.0100 | | | |
|  | | | 0.15 |
| 0423.0150 | | | |
|  | 40.0 | 18.8 | 0.25 |
| 0460.0250 | | | |
|  | 40.0 | 22.0 | 0.10 |
| 0419.0100 | | | |

AND THIS IS HOW YOU CAN BENEFIT FROM FILM-CUTTING BLADES BY LUTZ BLADES

- » Cleanly cutting edge with no edge build-up
- » Less cutting dust
- » High cutting speeds
- » Greater productivity thanks to fewer blade changes





CUSTOM BLADES | FILM AND FOIL | CHEMICAL FIBRES AND FIBREGLASS | MEDICAL | FOOD | DIY | AUTOMOTIVE | TEXTILES

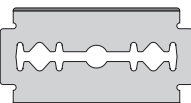
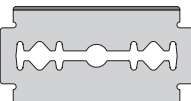
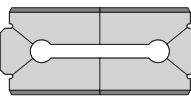
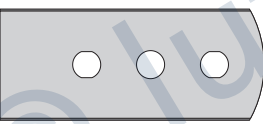
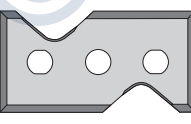

LUTZ BLADES website are subject to copyright and other proprietary rights.
LUTZ BLADES allows access to all its website content for viewing purposes. Copying and reproducing content (copy images etc.) for anything more than transient use is not permitted. This content may not be modified or used on other websites or networked computers without prior written approval by LUTZ GmbH & Co. KG.

LUTZ BLADES will pursue all violations against trademark law regarding its trademarks.
Copyright: © COPYRIGHT LUTZ GmbH & Co. KG, Solingen, Germany. All rights reserved. Copy, photos, graphics, technical drawings, layouts and other information used in all our publications and their arrangements on our

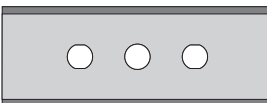
Proprietary rights: The owner of the brandnames used by LUTZ BLADES is LUTZ GmbH & Co. KG, Solingen, Germany (unless otherwise stated). Third Parties are explicitly prohibited from using any of the brandnames, logos or marks of any kind found there. This applies in particular to the internationally registered trademark "LUTZ BLADES exactly", which consists of words and graphic symbols.
E & OE. Brandnames marked with an asterisk (*) are not owned by LUTZ GmbH & Co. KG. Subject to our general terms & conditions on the Internet at www.lutz-blades.com.

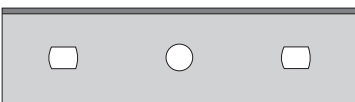
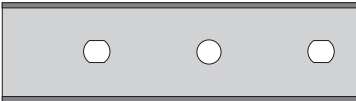
| Ref. | Length (mm) | Width (mm) | Thickn. (mm) |
|---|-------------|------------|--------------|
|  | | | |
| 0420.0100 | 43.0 | 22.2 | 0.10 |
| 0420.0150 | | | 0.15 |
| 0420.0200 | | | 0.20 |
| 0420.0300 | | | 0.30 |
|  | | | |
| 0436.0200 | 43.0 | 22.2 | 0.20 |
|  | | | |
| 0425.0100 | 43.5 | 19.0 | 0.10 |
| 0428.0200 | | | 0.20 |
|  | | | |
| 0520.0150 | 52.7 | 22.2 | 0.15 |
|  | | | |
| 0470.1000 | 43.0 | 22.0 | 1.00 |

| Ref. | Length (mm) | Width (mm) | Thickn. (mm) |
|--|-------------|------------|--------------|
|  | | | |
| 0600.0100 | 60.0 | 22.2 | 0.10 |
| 0600.0130 | | | 0.13 |
| 0600.0150 | | | 0.15 |
| 0600.0200 | | | 0.20 |
| 0600.0300 | | | 0.30 |
| 0500.0130 | 50.0 | | 0.13 |
| 0500.0150 | | | 0.15 |
| 0500.0300 | | | 0.30 |
|  | | | |
| 0800.0200 | 80.0 | 22.2 | 0.20 |
| 0800.0300 | | | 0.30 |
|  | | | |
| 0810.0200 | 80.0 | 22.2 | 0.20 |
| 0812.0200 | 100.0 | | |
|  | | | |
| 0850.0300 | 94.0 | 22.2 | 0.30 |

| Ref. | Length (mm) | Width (mm) | Thickn. (mm) |
|---|-------------|------------|--------------|
|  | | | |
| 0851.0200 | 150.0 | 22.2 | 0.20 |
|  | | | |
| 0852.0150 | 118.0 | 22.2 | 0.15 |
|  | | | |
| 0855.0200 | 150.0 | 22.2 | 0.20 |
| 0856.0200 | 140.0 | | 0.20 |
| 0857.0150 | 125.0 | | 0.15 |

IMPROVING ON THE NEAR-PERFECT – HARD COATINGS EXTEND LIFETIMES

As a supplier of high-quality special blades, we pride ourselves on being able to offer a wide selection of coatings (TiN, TiC, TiAlN, CrN, DLC, TiCN, PTFE etc.), which are designed to extend the lifetimes of the blades considerably when cutting

white film, aluminium foil, filled LLDPE and PET film, magnetic tape, OPP and BOPP film and other types of film. We will be pleased to advise you.







CUSTOM BLADES | FILM AND FOIL | CHEMICAL FIBRES AND FIBREGLASS | MEDICAL | FOOD | DIY | AUTOMOTIVE | TEXTILES

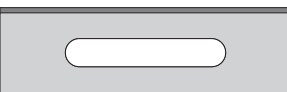
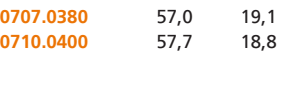
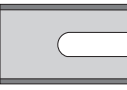
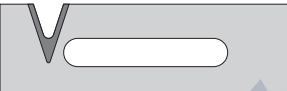
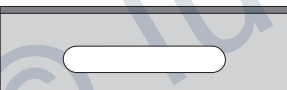
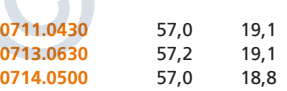

LUTZ BLADES website are subject to copyright and other proprietary rights.
LUTZ BLADES allows access to all its website content for viewing purposes. Copying and reproducing content (copy images etc.) for anything more than transient use is not permitted. This content may not be modified or used on other websites or networked computers without prior written approval by LUTZ GmbH & Co. KG.

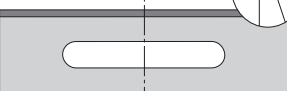
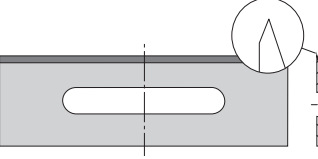
LUTZ BLADES will pursue all violations against trademark law regarding its trademarks.
Copyright: © COPYRIGHT LUTZ GmbH & Co. KG, Solingen, Germany. All rights reserved. Copy, photos, graphics, technical drawings, layouts and other information used in all our publications and their arrangements on our

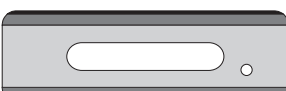
Proprietary rights: The owner of the brandnames used by LUTZ BLADES is LUTZ GmbH & Co. KG, Solingen, Germany (unless otherwise stated). Third Parties are explicitly prohibited from using any of the brandnames, logos or marks of any kind found there. This applies in particular to the internationally registered trademark "LUTZ BLADES exactly", which consists of words and graphic symbols.
E & OE. Brandnames marked with an asterisk (*) are not owned by LUTZ GmbH & Co. KG. Subject to our general terms & conditions on the Internet at www.lutz-blades.com.

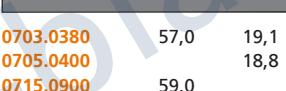
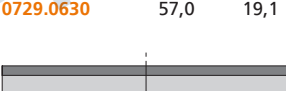
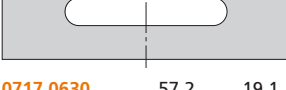
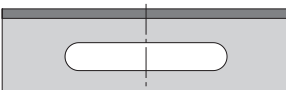
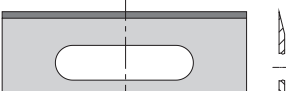
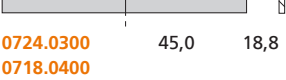
| Ref. | Length (mm) | Width (mm) | Thickn. (mm) |
|---|-------------|------------|--------------|
|  6030.0254 | 38,0 | 8,0 | 0,25 |
|  0707.0380 | 57,0 | 19,1 | 0,38 |
|  0710.0400 | 57,7 | 18,8 | 0,40 |
|  0697.0400 | 28,5 | 19,1 | 0,40 |
|  4307.1000 | 57,7 | 19,1 | 1,00 |
|  0711.0430 | 57,0 | 19,1 | 0,43 |
|  0713.0630 | 57,2 | 19,1 | 0,63 |
|  0714.0500 | 57,0 | 18,8 | 0,50 |
|  0709.0380 | | | 0,38 |
|  0730.1000 | 57,7 | 19,1 | 1,00 |

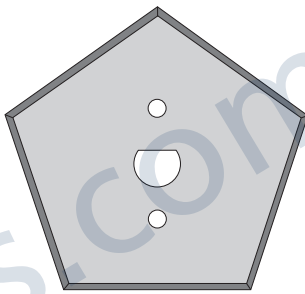
| Ref. | Length (mm) | Width (mm) | Thickn. (mm) |
|---|-------------|------------|--------------|
|  0700.0400 | 59,0 | 18,8 | 0,40 |
|  0698.0400 | 59,0 | 18,8 | 0,40 |
|  0703.0380 | 57,0 | 19,1 | 0,38 |
|  0705.0400 | | 18,8 | 0,40 |
|  0715.0900 | 59,0 | | 0,90 |
|  0729.0630 | 57,0 | 19,1 | 0,60 |
|  0717.0630 | 57,2 | 19,1 | 0,63 |
|  0724.0300 | 45,0 | 18,8 | 0,30 |
|  0718.0400 | | | 0,40 |

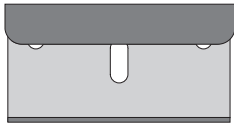
| Ref. | Length (mm) | Width (mm) | Thickn. (mm) |
|---|-------------|------------|--------------|
|  2650.0530 | 40,9 | 63,0 | 0,53 |
|  0308.0228 | 39,8 | 19,5 | 0,23 |
|  0300.0250 | 40,0 | 19,9 | 0,25 |

LUTZ BLADES - CIRCULAR PRODUCTS AND CUTTERS

Thanks to their razor-sharp cutting edges, their excellent flatness and hardening, our circular blades and cutters have been acknowledged for years as being among the best.

Something we keep working on every day! To keep your production rolling.



CUSTOM BLADES | FILM AND FOIL | CHEMICAL FIBRES AND FIBREGLASS | MEDICAL | FOOD | DIY | AUTOMOTIVE | TEXTILES

LUTZ BLADES website are subject to copyright and other proprietary rights.
LUTZ BLADES allows access to all its website content for viewing purposes. Copying and reproducing content (copy images etc.) for anything more than transient use is not permitted. This content may not be modified or used on other websites or networked computers without prior written approval by LUTZ GmbH & Co. KG.

LUTZ BLADES will pursue all violations against trademark law regarding its trademarks.
Copyright: © COPYRIGHT LUTZ GmbH & Co. KG, Solingen, Germany. All rights reserved. Copy, photos, graphics, technical drawings, layouts and other information used in all our publications and their arrangements on our

Proprietary rights: The owner of the brandnames used by LUTZ BLADES is LUTZ GmbH & Co. KG, Solingen, Germany (unless otherwise stated). Third Parties are explicitly prohibited from using any of the brandnames, logos or marks of any kind found there. This applies in particular to the internationally registered trademark "LUTZ BLADES exactly", which consists of words and graphic symbols.
E & OE. Brandnames marked with an asterisk (*) are not owned by LUTZ GmbH & Co. KG. Subject to our general terms & conditions on the Internet at www.lutz-blades.com.

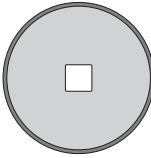
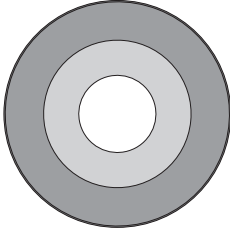
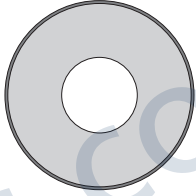
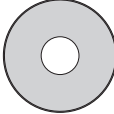
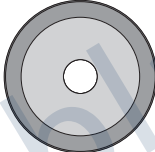
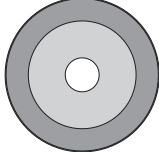
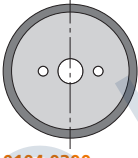
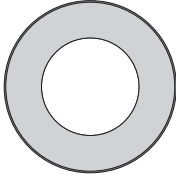
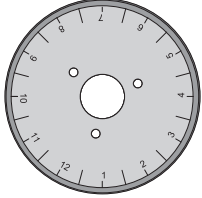
| Ref. | ø OD (mm) | ø ID (mm) | Thickn. (mm) | Ref. | ø OD (mm) | ø ID (mm) | Thickn. (mm) | Ref. | ø OD (mm) | ø ID (mm) | Thickn. (mm) |
|---|-----------|-----------|--------------|---|-----------|-----------|--------------|---|-----------|-----------|--------------|
|  | 40.0 | 7.0 | 0.30 |  | 100.0 | 34.0 | 1.00 |  | 50.0 | 20.0 | 0.20 |
| 0108.0300 | | | | 0125.1000 | | | | 0145.0200 | | | |
| 0114.0300 | 26.0 | | | | | | | | | | |
|  | 30.0 | 10.0 | 0.10 |  | 45.0 | 10.0 | 0.50 |  | 100.0 | 22.0 | 1.00 |
| 0129.0100 | | | | 0119.0500 | | | | 0115.1000 | | | |
|  | 30.0 | 5.0 | 0.30 |  | 30.0 | 17.0 | 0.10 |  | 44.0 | 10.0 | 0.30 |
| 0104.0300 | | | | 0120.0100 | 50.0 | 25.0 | 0.15 | 0159.0300 | | | |
| | | | | 0126.0150 | 70.0 | 48.0 | 0.15 | | | | |
| | | | | 0175.0150 | | | | | | | |

BLADES IN CUTTING MACHINES? THAT MAKES US PARTNERS.

We provide replacement blades for the following makes of machines:

- » Windmüller & Hölscher®*
- » Reifenhäuser®*
- » Starlinger®*
- » Kampf®*
- » Barmag®*
- » Brückner®*
- » SML/Lenzing®*
- » Atlas®*
- » Goebel®*
- ... and more









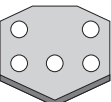
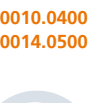
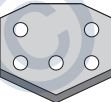

CUSTOM BLADES | FILM AND FOIL | CHEMICAL FIBRES AND FIBREGLASS | MEDICAL | FOOD | DIY | AUTOMOTIVE | TEXTILES

LUTZ BLADES website are subject to copyright and other proprietary rights.
LUTZ BLADES allows access to all its website content for viewing purposes. Copying and reproducing content (copy images etc.) for anything more than transient use is not permitted. This content may not be modified or used on other websites or networked computers without prior written approval by LUTZ GmbH & Co. KG.

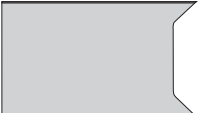
LUTZ BLADES will pursue all violations against trademark law regarding its trademarks.
Copyright: © COPYRIGHT LUTZ GmbH & Co. KG, Solingen, Germany. All rights reserved. Copy, photos, graphics, technical drawings, layouts and other information used in all our publications and their arrangements on our

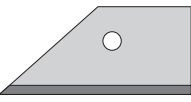
Proprietary rights: The owner of the brandnames used by LUTZ BLADES is LUTZ GmbH & Co. KG, Solingen, Germany (unless otherwise stated). Third Parties are explicitly prohibited from using any of the brandnames, logos or marks of any kind found there. This applies in particular to the internationally registered trademark LUTZ BLADES exactly. Which consists of words and graphic symbols.
E & OE. Brandnames marked with an asterisk (*) are not owned by LUTZ GmbH & Co. KG. Subject to our general terms & conditions on the Internet at www.lutz-blades.com.

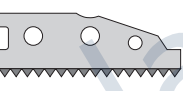
| Ref. | Length (mm) | Width (mm) | Thickn. (mm) |
|---|-------------|------------|--------------|
|  0021.0400 | 21.0 | 8.0 | 0.40 |
|  0023.0500 | 14.0 | 12.0 | 0.50 |
|  0016.0500 | 19.0 | 16.9 | 0.50 |
|  0010.0400 | 23.0 | 21.0 | 0.40 |
|  0014.0500 | | 21.0 | 0.50 |
|  0012.0500 | 23.8 | 21.0 | 0.50 |
|  0013.0200 | | 21.0 | 0.20 |
|  0441.0150 | 43.0 | 22.2 | 0.15 |

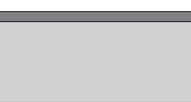
| Ref. | Length (mm) | Width (mm) | Thickn. (mm) |
|---|-------------|------------|--------------|
|  1052.0680 | 42.4 | 19.0 | 0.68 |
|  0918.0800 | 65.0 | 19.0 | 0.80 |
|  4011.0880 | 40.0 | 14.0 | 0.88 |
|  0801.0300 | 43.0 | 22.2 | 0.30 |
|  0802.0400 | 43.0 | 22.2 | 0.40 |

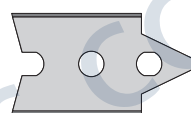
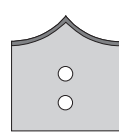
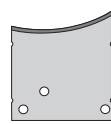
| Ref. | Length (mm) | Width (mm) | Thickn. (mm) |
|---|-------------|------------|--------------|
|  0840.0300 | 99.0 | 20.0 | 0.30 |
|  0220.0300 | 39.5 | 22.2 | 0.30 |
|  1240.0380 | 24.0 | 25.4 | 0.38 |
|  1350.0400 | 24.3 | 22.0 | 0.40 |

LUTZ BLADES MANUFACTURES OVER 500 DIFFERENT CUSTOM BLADES TO CUSTOMERS' DRAWINGS

Our product range consists of serrated, toothed, wavy, curved, notched, pointed, multi-sided, crimped special-purpose blades or combinations of several shapes and geometries.

Thanks to rapid prototyping and our highly flexible manufacturing technologies we are in a position to manufacture small (and even very small) runs of custom blades in only a few days!









CUSTOM BLADES | FILM AND FOIL | CHEMICAL FIBRES AND FIBREGLASS | MEDICAL | FOOD | DIY | AUTOMOTIVE | TEXTILES

LUTZ BLADES website are subject to copyright and other proprietary rights.
LUTZ BLADES allows access to all its website content for viewing purposes. Copying and reproducing content (copy images etc.) for anything more than transient use is not permitted. This content may not be modified or used on other websites or networked computers without prior written approval by LUTZ GmbH & Co. KG.

LUTZ BLADES will pursue all violations against trademark law regarding its trademarks.
Copyright: © COPYRIGHT LUTZ GmbH & Co. KG, Solingen, Germany. All rights reserved. Copy, photos, graphics, technical drawings, layouts and other information used in all our publications and their arrangements on our

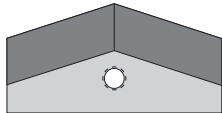
Proprietary rights: The owner of the brandnames used by LUTZ BLADES is LUTZ GmbH & Co. KG, Solingen, Germany (unless otherwise stated). Third Parties are explicitly prohibited from using any of the brandnames, logos or marks of any kind found there. This applies in particular to the internationally registered trademark LUTZ BLADES exactly. Which consists of words and graphic symbols.
E & OE. Brandnames marked with an asterisk (*) are not owned by LUTZ GmbH & Co. KG. Subject to our general terms & conditions on the Internet at www.lutz-blades.com.

| Ref. | Length (mm) | Width (mm) | Thickn. (mm) |
|--|-------------|------------|--------------|
|  6435.0400 | 29.0 | 5.0 | 0.40 |
|  9530.2500 | 90.0 | 14.0 | 2.50 |
|  3290.0500 | 18.8 | 4.8 | 0.50 |

| Ref. | Length (mm) | Width (mm) | Thickn. (mm) |
|--|-------------|------------|--------------|
|  0027.2000 | 50.0 | 25.0 | 2.00 |
|  0019.0400 | 12.0 | 4.1 | 0.40 |
|  9605.0400 | 50.0 | 20.0 | 0.40 |
|  0045.0680 | 7.0 | 7.0 | 0.68 |
|  0076.1200 | 10.3 | 12.0 | 1.20 |

| Ref. | Length (mm) | Width (mm) | Thickn. (mm) |
|--|-------------|------------|--------------|
|  0015.0700 | 21.5 | 11.5 | 0.70 |
|  0026.0500 | 41.0 | 5.6 | 0.50 |
|  4440.0700 | 32.0 | 32.0 | 0.70 |
|  9810.0650 | 23.0 | 15.6 | 0.65 |

INDUSTRIAL BLADES BY LUTZ BLADES HAVE THE FOLLOWING CHARACTERISTICS

- » The best materials
- » Adherence to the closest tolerances
- » Optimum hardness
- » Selected high-performance coatings







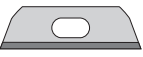

CUSTOM BLADES | FILM AND FOIL | CHEMICAL FIBRES AND FIBREGLASS | MEDICAL | FOOD | DIY | AUTOMOTIVE | TEXTILES

LUTZ BLADES website are subject to copyright and other proprietary rights.
LUTZ BLADES allows access to all its website content for viewing purposes. Copying and reproducing content (copy images etc.) for anything more than transient use is not permitted. This content may not be modified or used on other websites or networked computers without prior written approval by LUTZ GmbH & Co. KG.

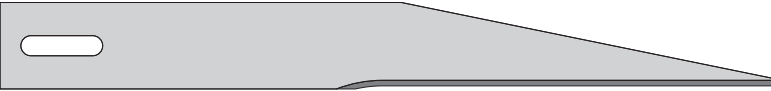
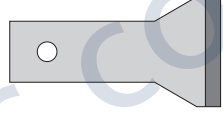
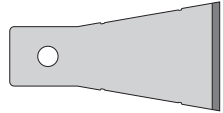
LUTZ BLADES will pursue all violations against trademark law regarding its trademarks.
Copyright: © COPYRIGHT LUTZ GmbH & Co. KG, Solingen, Germany. All rights reserved. Copy, photos, graphics, technical drawings, layouts and other information used in all our publications and their arrangements on our

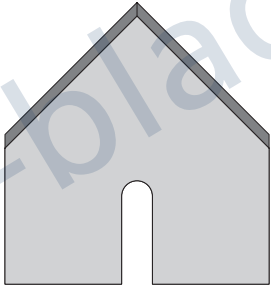
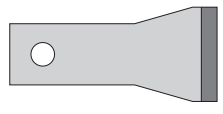
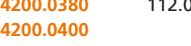
Proprietary rights: The owner of the brandnames used by LUTZ BLADES is LUTZ GmbH & Co. KG, Solingen, Germany (unless otherwise stated). Third Parties are explicitly prohibited from using any of the brandnames, logos or marks of any kind found there. This applies in particular to the internationally registered trademark "LUTZ BLADES exactly", which consists of words and graphic symbols.
E & OE. Brandnames marked with an asterisk (*) are not owned by LUTZ GmbH & Co. KG. Subject to our general terms & conditions on the Internet at www.lutz-blades.com.

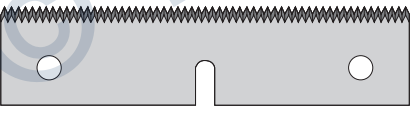
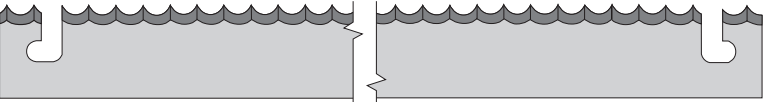
| Ref. | Length (mm) | Width (mm) | Thickn. (mm) | Ref. | Length (mm) | Width (mm) | Thickn. (mm) | Ref. | Length (mm) | Width (mm) | Thickn. (mm) |
|---|-------------|------------|--------------|--|-------------|------------|--------------|--|-------------|------------|--------------|
|  2530.0600 | 31.0 | 9.0 | 0.60 |  2525.0300 | 33.3 | 7.8 | 0.30 |  2194.0400 | 14.0 | 12.9 | 0.40 |
|  9540.1000 | 250.0 | 28.0 | 1.00 |  1406.0800 | 46.0 | 24.0 | 0.80 |  1408.1000 | 46.5 | 24.2 | 1.00 |
|  4200.0380 | 112.0 | 19.0 | 0.38 |  9580.1200 | 60.0 | 64.0 | 1.20 |  1411.0800 | 44.0 | 20.0 | 0.80 |
|  4200.0400 | | | 0.40 |  2222.0400 | 40.5 | 8.2 | 0.40 |  1412.1000 | 46.0 | 13.2 | 1.00 |
|  8115.0510 | 108.0 | 25.4 | 0.51 |  3053.1000 | 499.0 | 20.0 | 1.00 | | | | |

CHOICE OF MATERIAL

Our range of products covers blades of between 0.06 and 3.0 mm in thickness and with final hardness ratings of 40 - 85 HRc.

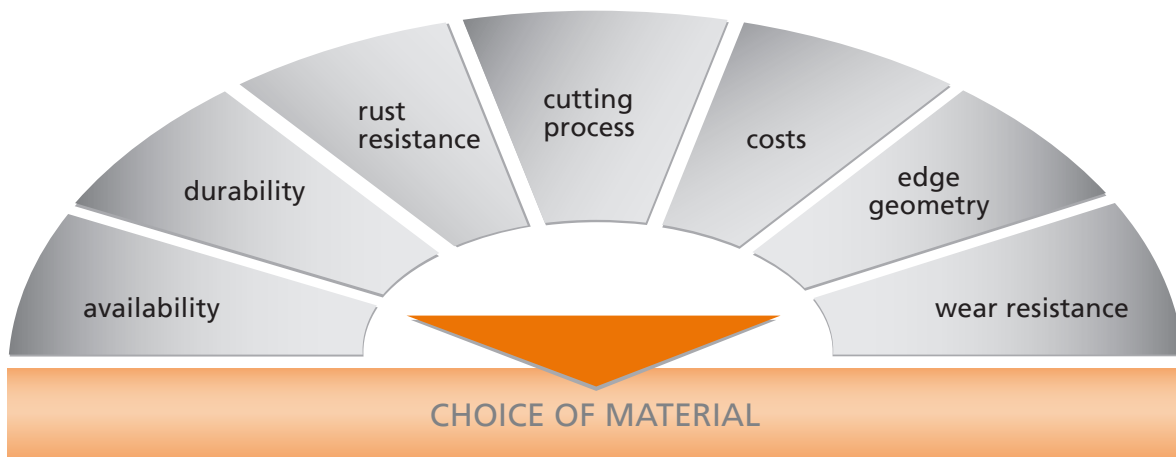

- Our range of materials includes:
- » Carbon steels
 - » Stainless and rust-resistant steels
 - » Highspeed steels (HSS)
 - » Tool steels
 - » Tungsten carbides
 - » Ceramics

LUTZ BLADES website are subject to copyright and other proprietary rights.
LUTZ BLADES allows access to all its website content for viewing purposes. Copying and reproducing content (copy images etc.) for anything more than transient use is not permitted. This content may not be modified or used on other websites or networked computers without prior written approval by LUTZ GmbH & Co. KG.

LUTZ BLADES will pursue all violations against trademark law regarding its trademarks.
Copyright: © COPYRIGHT LUTZ GmbH & Co. KG, Solingen, Germany. All rights reserved. Copy, photos, graphics, technical drawings, layouts and other information used in all our publications and their arrangements on our

Proprietary rights: The owner of the brandnames used by LUTZ BLADES is LUTZ GmbH & Co. KG, Solingen, Germany (unless otherwise stated). Third Parties are explicitly prohibited from using any of the brandnames, logos or marks of any kind found there. This applies in particular to the internationally registered trademark LUTZBLADES exactly, which consists of words and graphic symbols.

E & OE. Brandnames marked with an asterisk (*) are not owned by LUTZ GmbH & Co. KG. Subject to our general terms & conditions on the Internet at www.lutz-blades.com.

CUTTING EDGE SHAPES

For the definition of edge type and bevel configuration see the following matrix:



LUTZ BLADES website are subject to copyright and other proprietary rights.
LUTZ BLADES allows access to all its website content for viewing purposes. Copying and reproducing content (copy images etc.) for anything more than transient use is not permitted. This content may not be modified or used on other websites or networked computers without prior written approval by LUTZ GmbH & Co. KG.

LUTZ BLADES will pursue all violations against trademark law regarding its trademarks.
Copyright: © COPYRIGHT LUTZ GmbH & Co. KG, Solingen, Germany. All rights reserved. Copy, photos, graphics, technical drawings, layouts and other information used in all our publications and their arrangements on our

Proprietary rights: The owner of the brandnames used by LUTZ BLADES is LUTZ GmbH & Co. KG, Solingen, Germany (unless otherwise stated). Third Parties are explicitly prohibited from using any of the brandnames, logos or marks of any kind found there. This applies in particular to the internationally registered trademark "LUTZ BLADES exactly", which consists of words and graphic symbols.

E & OE. Brandnames marked with an asterisk (*) are not owned by LUTZ GmbH & Co. KG. Subject to our general terms & conditions on the Internet at www.lutz-blades.com.

| | | single edged | double edged | convex | concave |
|-----------|--|--------------|--------------|--------|---------|
| two sided | | | | | |
| | | | | | |
| | | | | | |
| | | | | | |
| | | | | | |
| | | | | | |
| one sided | | | | | |
| | | | | | |
| | | | | | |
| | | | | | |
| | | | | | |
| | | | | | |

COATINGS

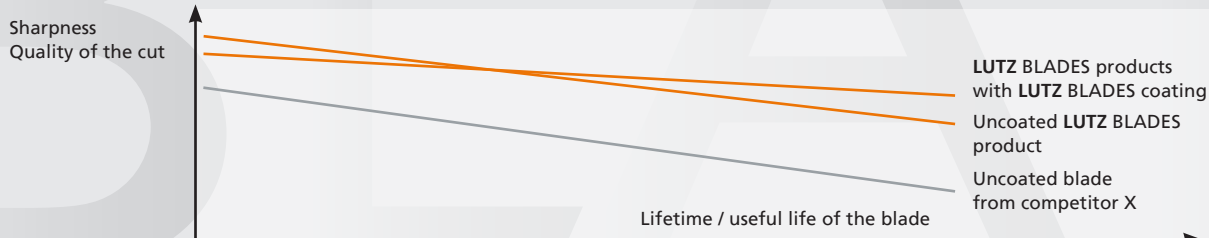

The LUTZ BLADES coatings range includes the following choices:

TiN

Standard hard coating with tough resistance to wear with a relatively high coefficient of friction (compared with steel as a reference material: 0.4 to 0.7), usually gold coloured, safe use at up to approx. 300 °C.

TiC

Has lower resistance to wear than TiN and a considerably lower coefficient of friction (compared with steel as a reference material: 0.3 to 0.5), usually charcoal grey.

TiCN

Takes a position between the high wear resistance of TiN and the low coefficient of friction of TiC, relative position between TiN and TiC depending on C and N content, usually charcoal grey.

TiAIN

Has greater resistance to oxidation than TiN with a comparable coefficient of friction, usually charcoal grey.

ZrN

With wear resistance similar to TiN, but with a more dense morphology than TiN and, as a result, more resistant to pitting under comparable load, usually steel colour.

CrN

Lower wear resistance than TiN. The advantage of CrN is it has a lower inherent tension than TiN. As a result, can be used for applications with high bending loads.

DLC

Has a high wear resistance and a low coefficient of friction (approx. 0.4 compared with steel as a reference); sensitive to impacts and high temperatures (between 100° and 300 °C depending on structure).

Teflon® (PTFE)

Non-stick coating Teflon® (PTFE), very low static friction allows a smooth cut, therefore a popular coating for medical devices. Because of the low surface tension almost no contamination from the cut goods. Acid and base-resistant, not suitable in combination with Na (sodium). Temperature resistant up to 250°C (480°F). Medium wear resistance.

Coloured lacquer

Applied to entire surface, acts as an aid to sorting different material thicknesses and as anticorrosion protection.

Blueing and blackening

Applied to entire surface, some anticorrosion protection and thickness protection, also aids differentiation.

LUTZ BLADES website are subject to copyright and other proprietary rights.
LUTZ BLADES allows access to all its website content for viewing purposes. Copying and reproducing content (copy images etc.) for anything more than transient use is not permitted. This content may not be modified or used on other websites or networked computers without prior written approval by LUTZ GmbH & Co. KG.

LUTZ BLADES will pursue all violations against trademark law regarding its trademarks.
Copyright: © COPYRIGHT LUTZ GmbH & Co. KG, Solingen, Germany. All rights reserved. Copy, photos, graphics, technical drawings, layouts and other information used in all our publications and their arrangements on our

Proprietary rights: The owner of the brandnames used by LUTZ BLADES is LUTZ GmbH & Co. KG, Solingen, Germany (unless otherwise stated). Third Parties are explicitly prohibited from using any of the brandnames, logos or marks of any kind found there. This applies in particular to the internationally registered trademark "LUTZ BLADES exactly", which consists of words and graphic symbols.

E & OE. Brandnames marked with an asterisk (*) are not owned by LUTZ GmbH & Co. KG. Subject to our general terms & conditions on the Internet at www.lutz-blades.com.