

Precision Parts  
Manufacturer & Exporter

For Flexible Packaging Industry

## SPARE PARTS FOR LAMINATORS

NORDMECCANICA, COMEXI, UTECO, SCHIAVI, etc.



info@technocnc.in

AHMEDABAD - INDIA - [www.technocnc.in](http://www.technocnc.in)

**Screw support for EUROPA filter**

**Plastic static mixer steel protection**

Order Code MA 113.01.52 - L = 27 cm.

**Screws for Mixing head cleaning**

Matrix M10 -  $\phi$  2,80 mm. base /  $\phi$  1,75 mm. cat.

Matrix M4S -  $\phi$  2,25 mm. base / 1,50 mm. cat.

**Bored screw**  
RA 18087

**Bonded washer**  
RA 16726

**Screw eye**  
RA 18141

**Mixing head for Matrix M4 - M5**



**EUROPA filter for adhesive dispenser**

Single

Double Web

**Plastic static mixer**

Order Cod. POME 1032 - L = 35cm.

Order Cod. POME 1024 - L = 27cm.

**Nylon mixing head cap**

for Matrix M1, M2, M3, M4 and M5

**Brass mixing head complete**

for Matrix M3 - M5 - M10

for Matrix M4 - M5

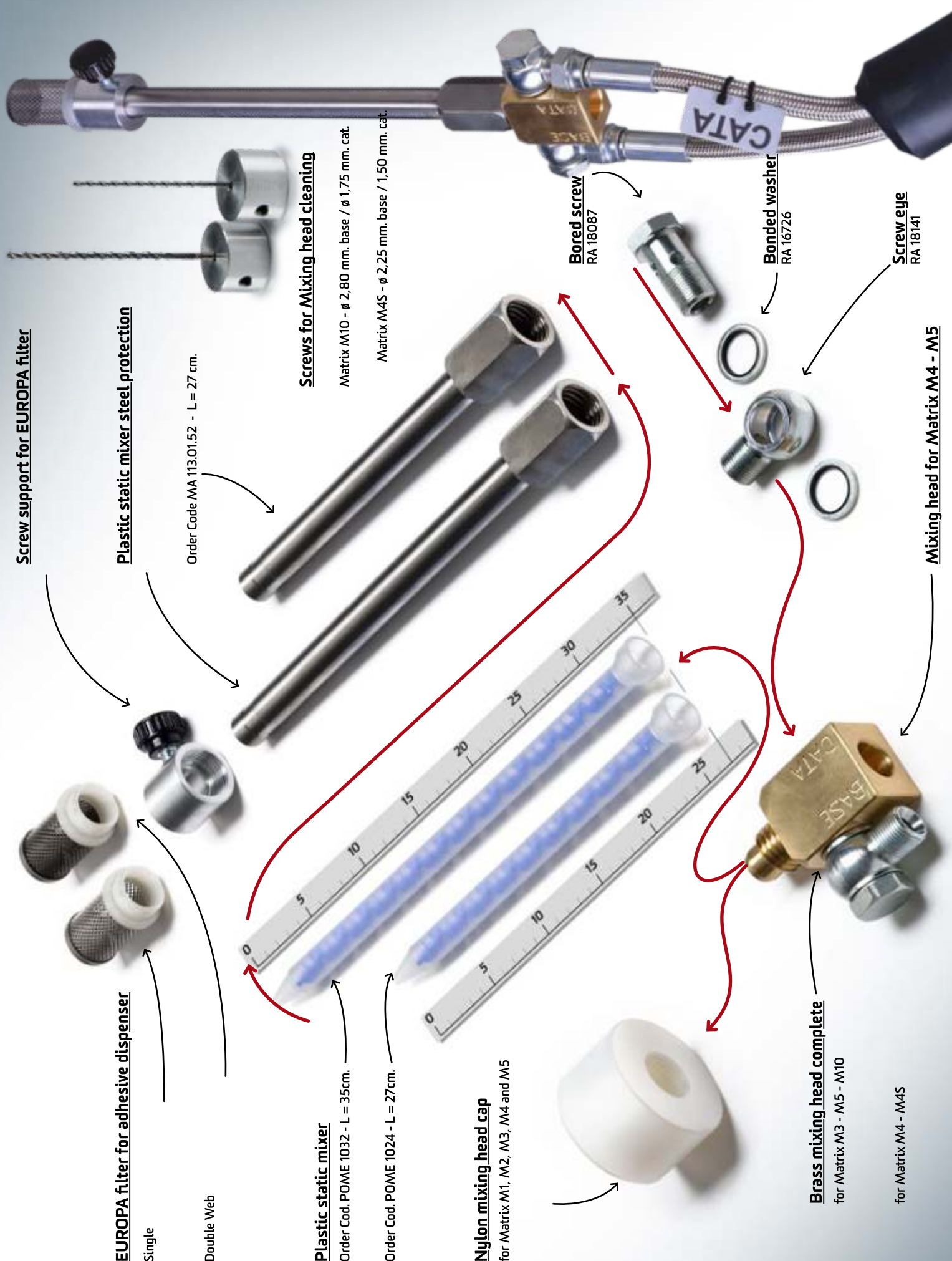

# MIXER SL **MATRIX** - spare parts

3/8" 48V 250W 4mt  
80 bar - temp. max. 150 °C  
for Matrix M3, M4 and M5

Other sizes on request

Double Heated



Single Heated



1" 48V 500W 3.5mt  
for Matrix M4 from Matr:006; M3 and M5 all version

Teflon Seal for gear pump

for M4S

for M10

for M2 - M3 - M5

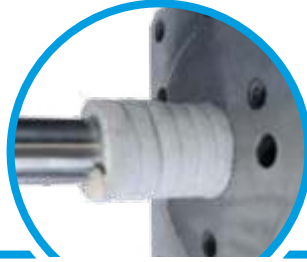

Metering Pump



Gear Box



Electric Motor

M2 - M3  
M5

for Matrix M2 - M3 - M5



Metering Pump

for M4  
for M4S



Gear Box valid for M4/M4S

CATA side  
BASE side



Electric Motor

for Matrix M4 - M4S



Metering Pump\*



Gear Box



Electric Motor

for Matrix M10

# SOLVENTMIXER - spare parts

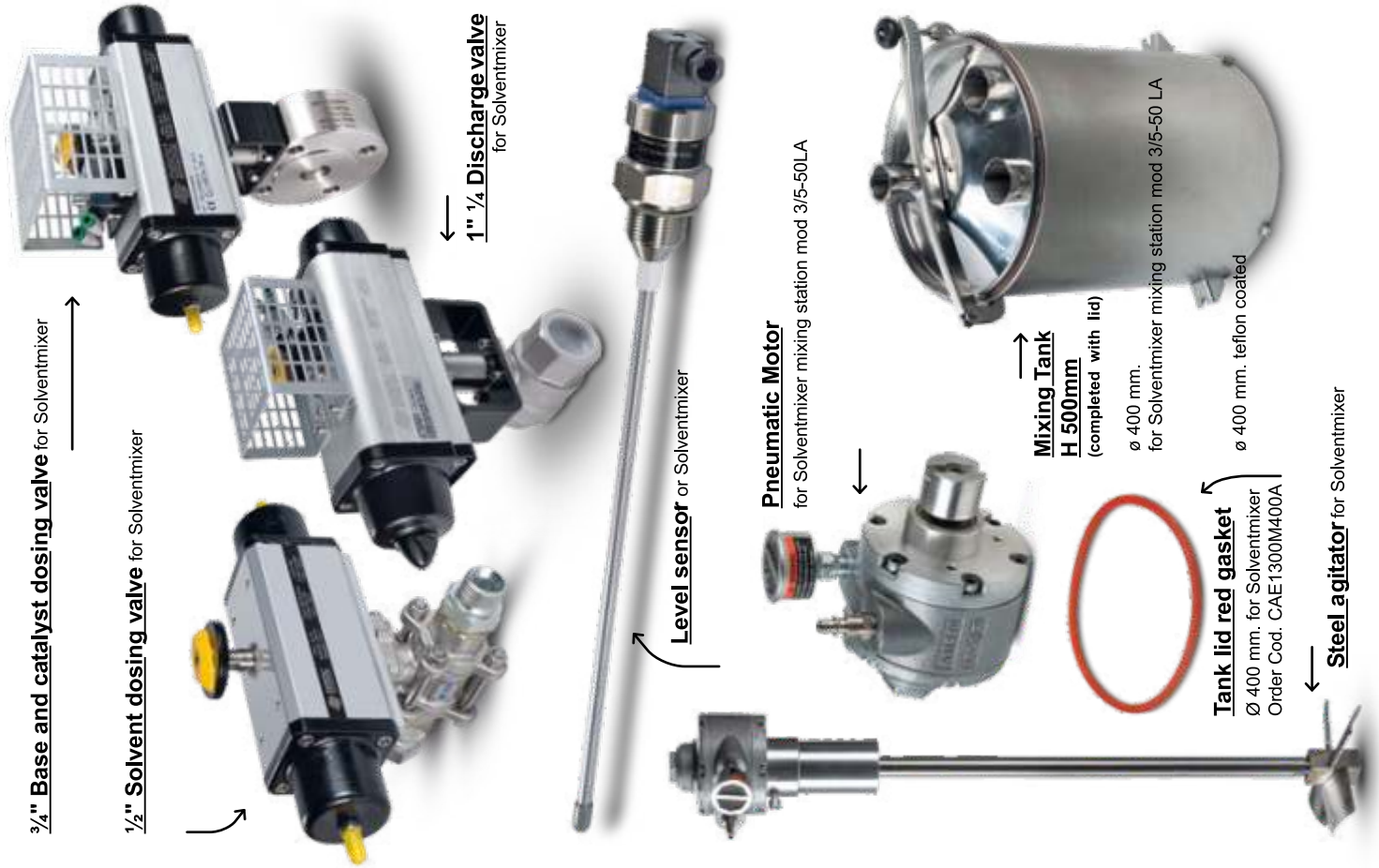

# PUMPS for MIXER

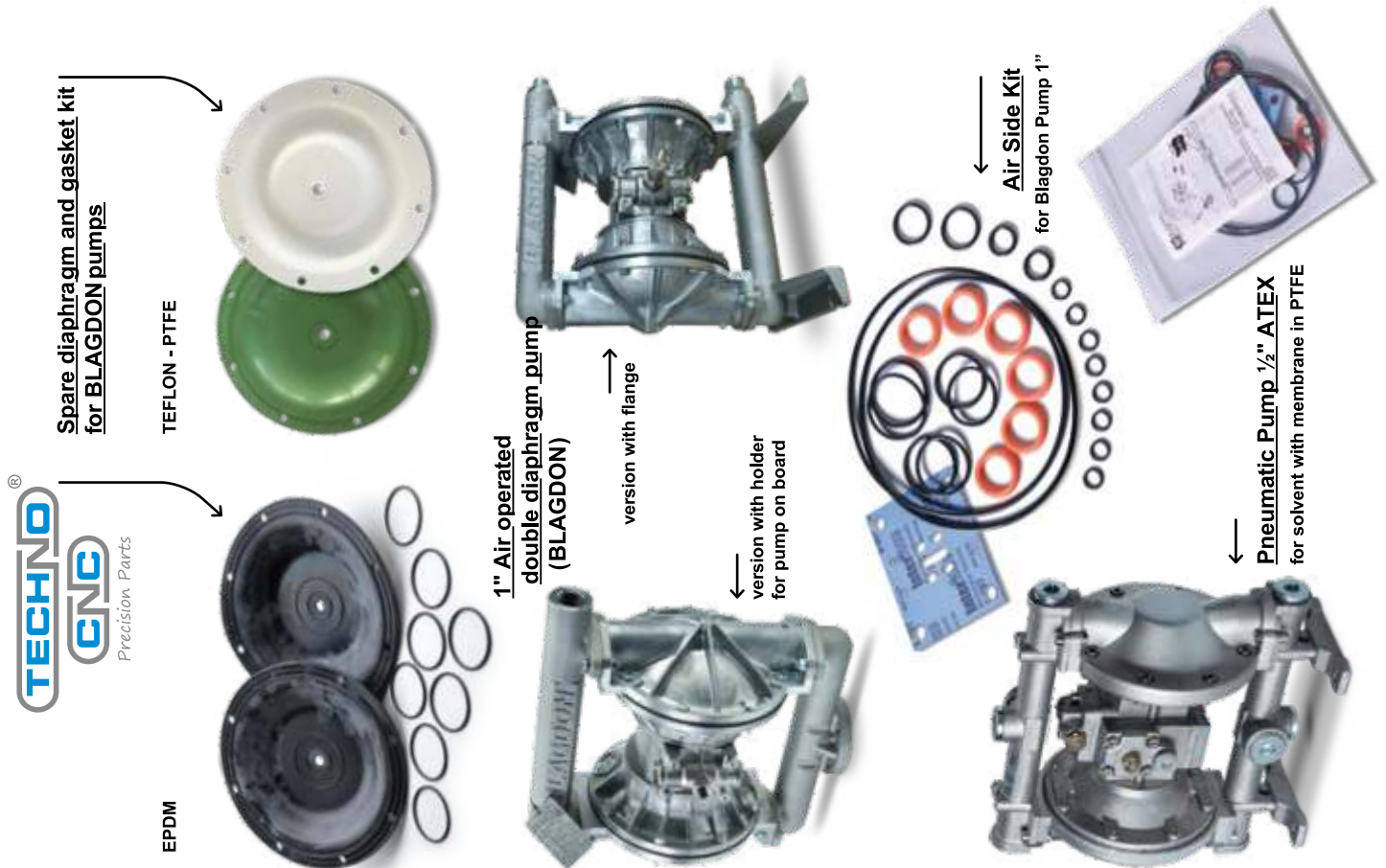

# TEFLON DAMS

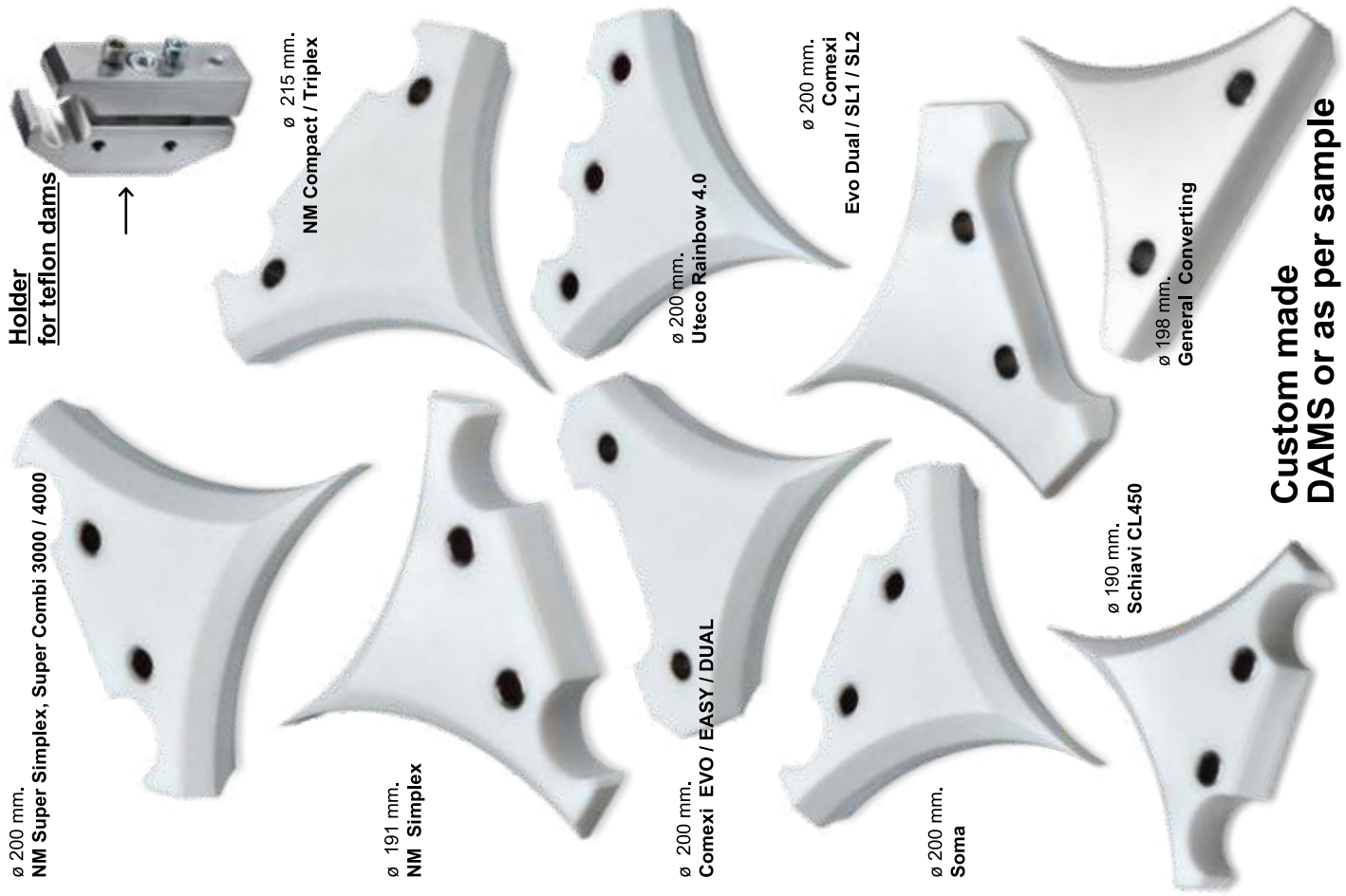

**Holder for teflon dams**

ø 200 mm.  
NM Super Simplex, Super Combi 3000 / 4000

ø 215 mm.  
NM Compact / Triplex

ø 191 mm.  
NM Simplex

ø 200 mm.  
Comexi EVO / EASY / DUAL

ø 200 mm.  
Uteco Rainbow 4.0

ø 200 mm.  
Comexi  
Evo Dual / SL1 / SL2

ø 200 mm.  
Soma

ø 190 mm.  
Schiavi CL450

ø 198 mm.  
General Converting

**Custom made DAMS or as per sample**

Available teflon dams system for Bobst machine and other kind of laminating machine

# NM WORLDMIXER - spare parts

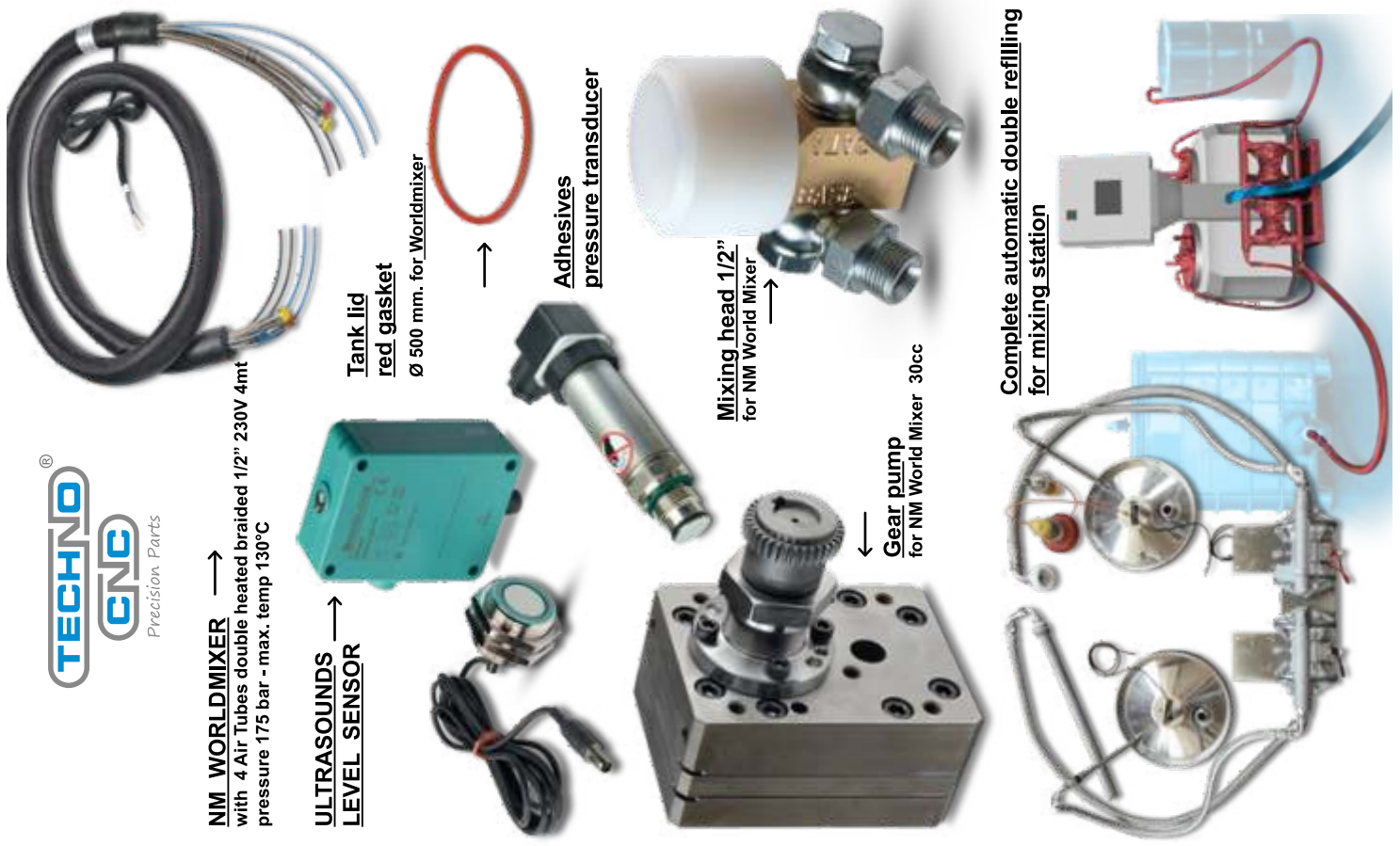

**NM WORLDMIXER**  
with 4 Air Tubes double heated braided 1/2" 230V 4mt  
pressure 175 bar - max. temp 130°C

**ULTRASOUNDS LEVEL SENSOR**

**Tank lid red gasket**  
ø 500 mm. for Worldmixer

**Adhesives pressure transducer**

**Mixing head 1/2"**  
for NM World Mixer

**Gear pump**  
for NM World Mixer 30cc

**Complete automatic double refilling for mixing station**

# LAMINATING MACHINE - spare parts



**Toothed cone Ø 3" extended**  
Alluminium

for Simplex, Super Simplex, Nexus  
Alluminium

Iron

**Toothed cone Ø 3"**

**Toothed cone Ø 6" extended**  
Alluminium

**Toothed cone Ø 6"**

for Simplex,  
Super Simplex,  
Super Combi 3000/4000,  
Nexus  
Alluminium  
Iron

**Ball nut**

D. 25

D. 32

**Shaft for toothed cone**  
operator side  
transmission side



different version available (NM - Comexi)

Cone pin for motorized unwinder  
for COMEXI female gear box



Cone pin for NM Super Simplex  
Super Combi modern machine



Cone pin for motorized  
rewinder for NM



Cone pin for motorized  
unwinder  
for NM Supersimplex



**Worm drive**  
for Simplex and Super Simplex  
or as per sample



**6" Self-centering  
pneumomechanical chuck**  
for aluminium coils



# LAMINATING MACHINE - spare parts



**Toothed Pulley**  
for coating transmission  
NM S, Simplex - S, Combi



**Pressure booster**



**Ball bearing bushins**  
for NM pressure roll



**Gear box**  
for Super Simplex unwinder



**Radial ball bearing**  
for aluminium rolls (in special execution)  
for COMEXI machine  
for NM machine



**Gear box**  
for Super Simplex dosing and transfer rolls



**Gear box**  
for Super Simplex winder



**Feeler Gauge**  
mm 0,08 - 839,08 LFT  
width 13mm. - length 5m  
mm 0,10 - 839,18 LFT  
width 13mm. - length 5m

**Adhesive level sensor, special corrosion coating**



**Indicator for NM chromed rolls position**



**FIFE web guiding system**



**Water Rotary Joint**

3/4"  
1"  
other dimensions



**SCHMIT joint**

Ø 120 mm.  
for Super Simplex, Easy, Nexus Evo

Ø 100 mm.  
for Simplex, Entry, Nexus One



**Adhesive head piston movimentation**

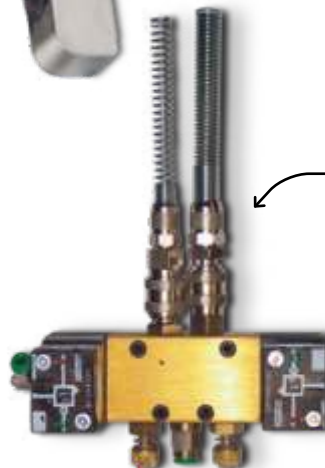

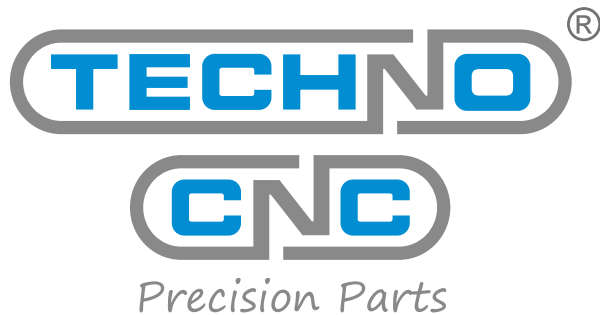

## TECHNO CNC

79, Girivar Globe Industrial Park, B/h. Sahjanand Business Park,  
Sardar Patel Ring Road, Odhav, Ahmedabad 382415 Gujarat, India

Cell: +91 97277 26697, (Off) +91 97140 06697

Email: [info@technocnc.in](mailto:info@technocnc.in)

[www.technocnc.in](http://www.technocnc.in)

TECHNO CNC  
WhatsApp Business Account



**Precision Parts**  
**Manufacturer & Exporter**